

CONNECTOR PLATES

• Holes are drilled to accept $\frac{3}{8}$ " and $\frac{1}{2}$ " bolts

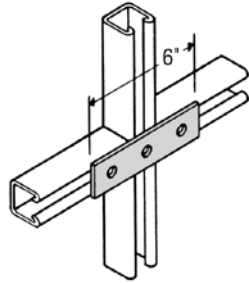

CS-101
3 Hole Flat

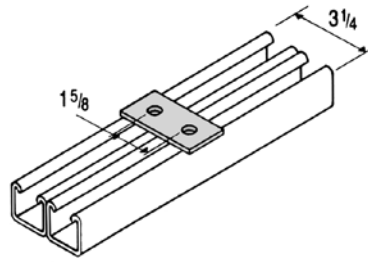

CS-102
2 Hole Flat

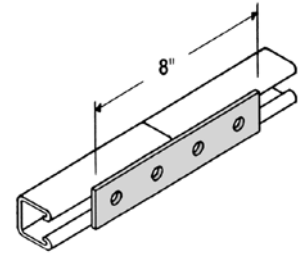

CS-104
4 Hole Straight

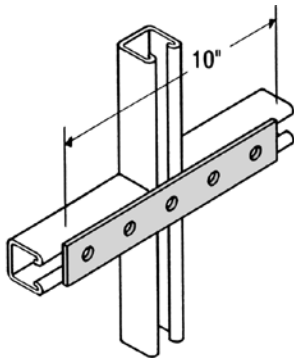

CS-105
5 Hole Straight

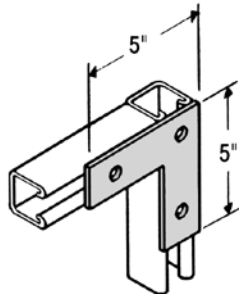

CS-109
Flat L

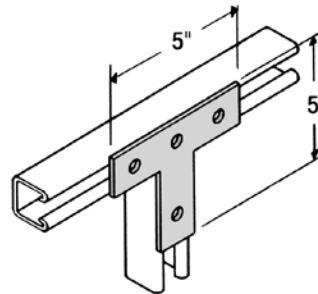

CS-110
Flat T

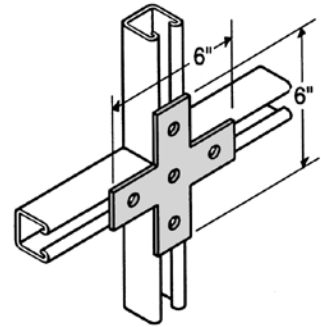

CS-111
Flat Cross

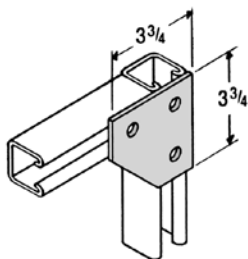

CS-112
3 Hole Heavy Duty L

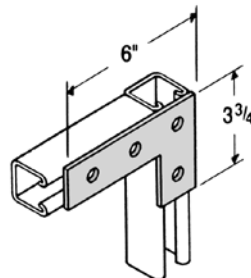

CS-113
4 Hole L

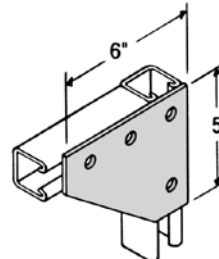

CS-114
4 Hole Heavy Duty L

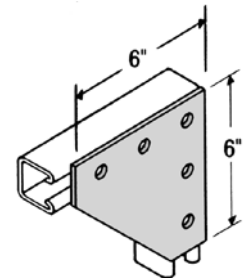

CS-115
5 Hole Heavy Duty L

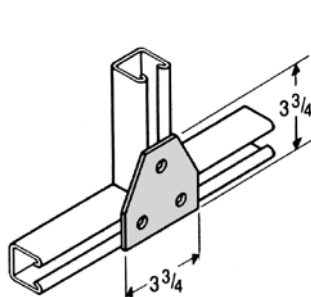

CS-116
3 Hole Heavy Duty T

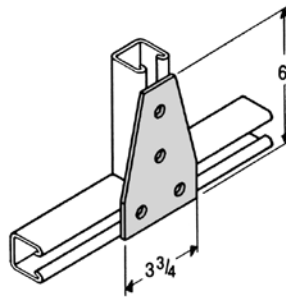

CS-117
4 Hole Heavy Duty T

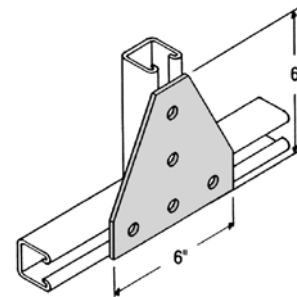

CS-118
5 Hole Heavy Duty T